

PergoLine Ruby Plus





PergoLine Ruby Plus



Dimensions in mm Boyutlar mm

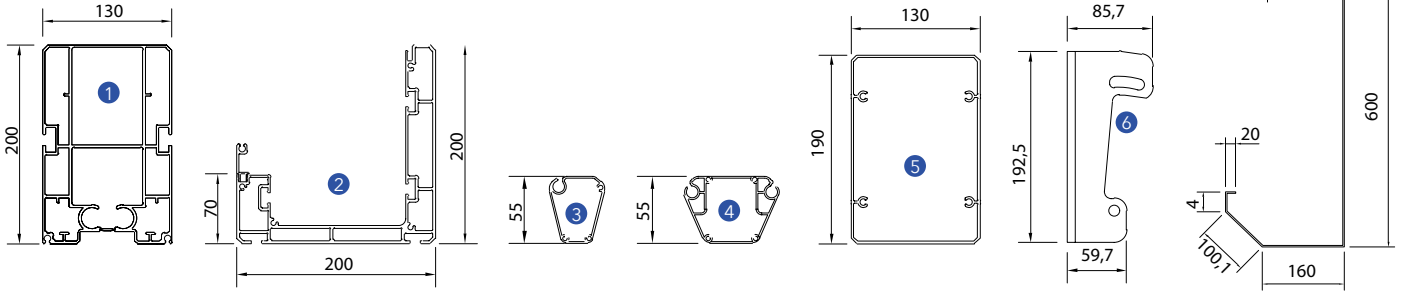
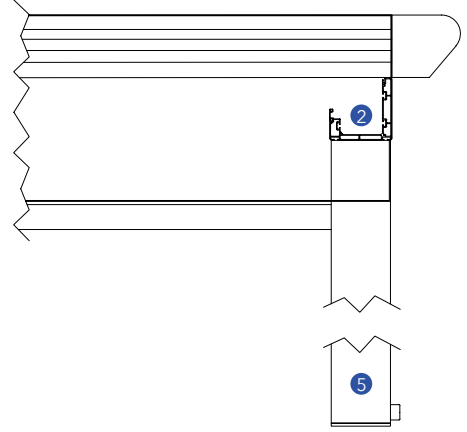
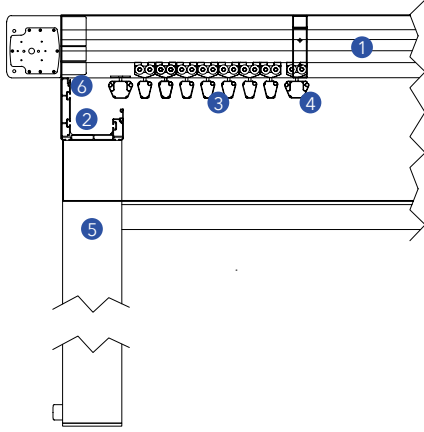

Frontal view / Önden görünüş

Side view / Yandan görünüş

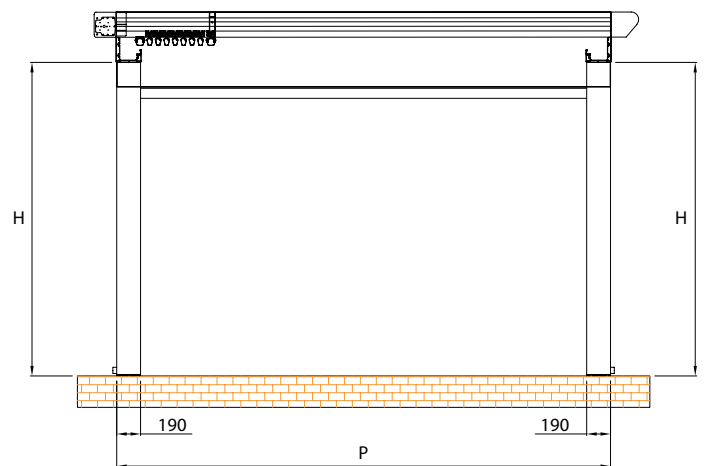
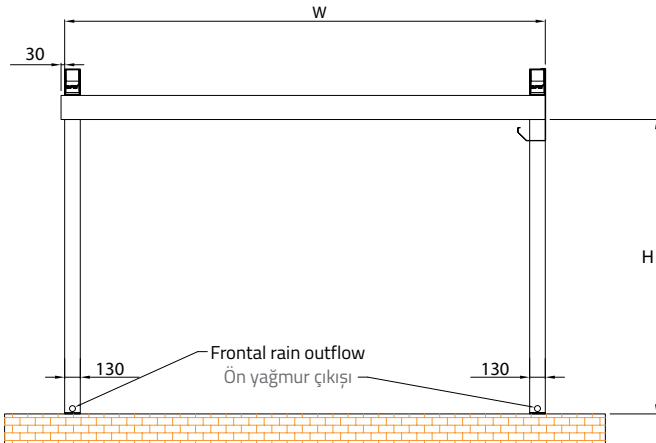

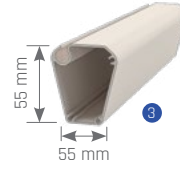
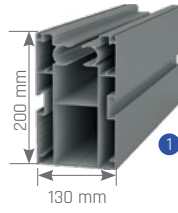

Fabric Profile

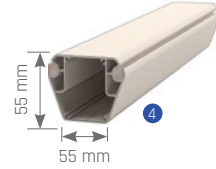

Fabric Profile

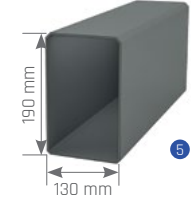

Pole

	Max. width	Max. projection
Single Form	450 cm	600 cm
Double Form	800 cm	600 cm

Extruded Frontal Gutter (Water-drain)

Technical Details Teknik Ayrıntılar

If this structure doesn't have these following features, Byart Group will not be responsible for possible knapsacks of water or similar problems concerning the running-off of rainwater. Flowing profiles number is indicative, inclinations are the least guaranteed for a correct outflow of rainwater. For inferior inclinations to least measures pointed in the table, it is possible to add one or more intermediary rails, except for technical office approval.

Eğer bu yapı aşağıda belirtilen özelliklere sahip değilse Byart Group yağmur oluklarından veya yağmur suyunun akmasından kaynaklanan benzer sorunlardan sorumlu olmayacaktır. Yağmur suyunun doğru yere akması için doğru eğimin verilmesi şarttır, bunun da belirleyicisi raylardır. Tabloda belirtilen en düşük ölçülere yönelik daha az eğimler için teknik ofis onayı doğrultusunda bir veya birden fazla ara ray eklenmesi mümkündür.

Ceiling Application / Tavan Uygulaması

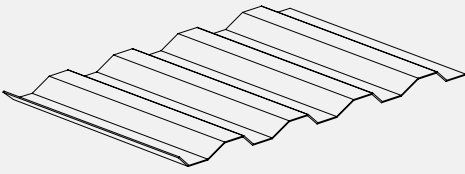

Connection Roof / Bağlantı Çatısı

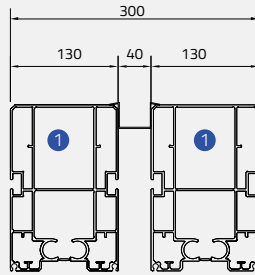

Rüzgar önleyici profil / Anti -Wind profile

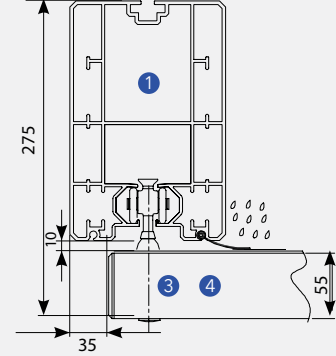

Roof Detail / Çatı Detayı

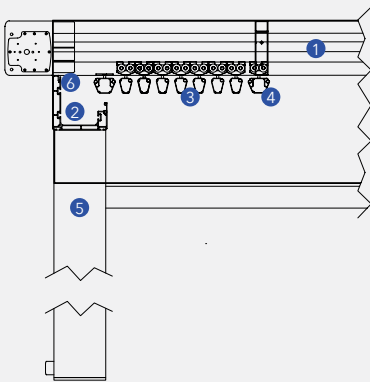

Foot / Ayak

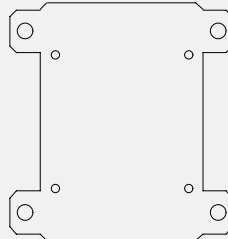

Wall application bracket / Duvar uygulama köşebendi

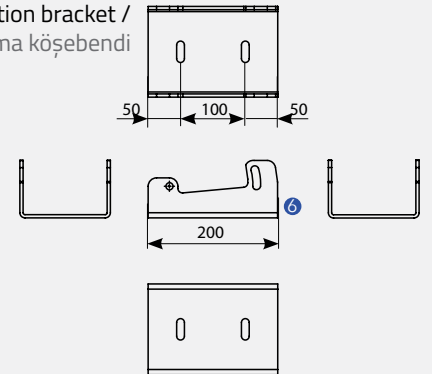

Technical Legend / Teknik Tanım

- 1 Rails Ray
- 2 Extruded Frontal Water-drain Haddeden Çekilmiş Ön Su Tahliyesi
- 3 Middle Flowing Profile Orta Akış Profili
- 4 Last Flowing Profile Son Akış Profili
- 5 Pole Direk
- 6 Wall Application Bracket Duvar Uygulama Köşebendi
- 7 Side Gutter Yan Oluk

- H1 Back Height Arka Yükseklik
- H2 Frontal Height Ön Yükseklik
- P Projection Açılım
- S Eğim Inclination
- W Width Genişlik
- X Packing Paketleme

PergoLine Ruby Plus

Single Form / Tekli Form

Single form with 2 frontal poles + 1 motor
2 ön direkli tekli form + 1 motor

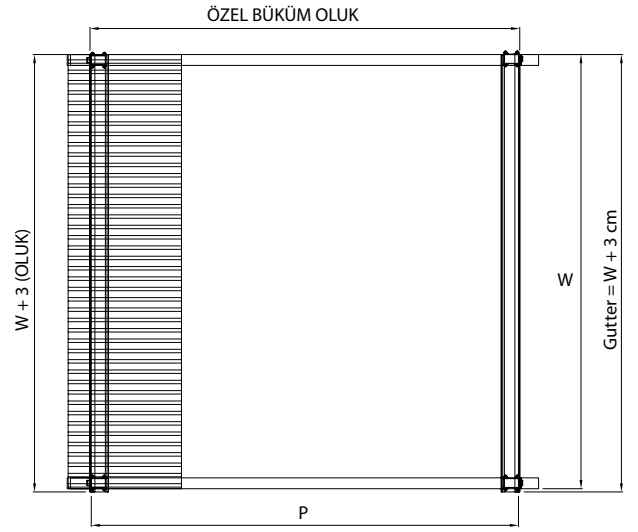
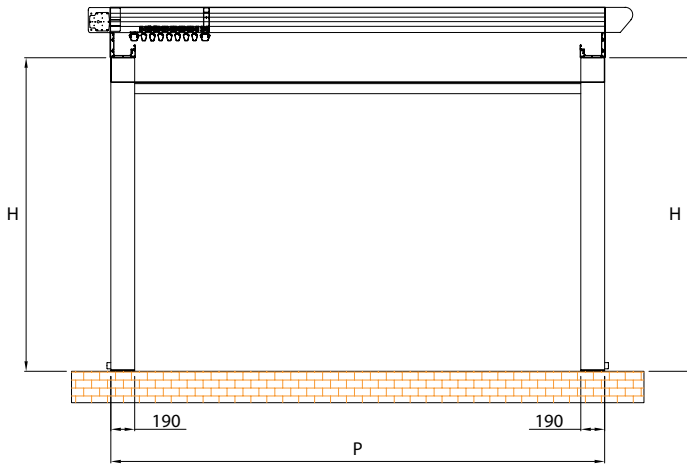

COLORS RENKLER

9016 1013 8017 9005 9006 7043 7016



Other Colors +10%
Diğer Renkler +%10

Double Form /ikili Form

Double form with 3 frontal poles + 2 motors
3 ön direkli ikili form + 2 motor

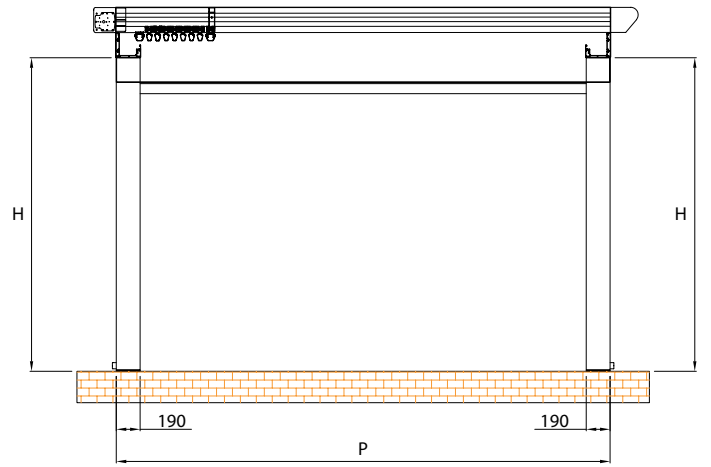
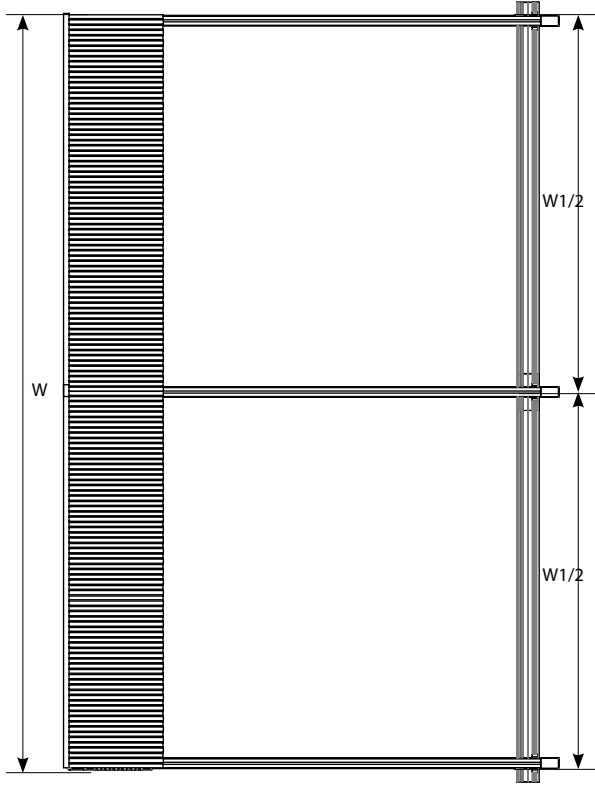

COLORS RENKLER

9016 1013 8017 9005 9006 7043 7016



Other Colors +10%
Diğer Renkler +%10